

Cast alloy finial

46mm dia.

6 / 7.5m

Specification Description:

6m/7.5m Al flagpole 80mm OD x 2mm wall, top 2m tapered to 46mm OD, cast Al mushroom finial, white powder coated finish, spigot B [aluminium base plate 195mm square + 2m structural aluminium tube] with 4 x M16 x 600mm long galvanised steel foundation bolts, external halyard and flag clips ready to fly a 2 yard flag. #FP680SAEH

Pole	External Halyard Flagpole
Height	6 / 7.5 Metre
Material	Aluminium 6063T6
Finishes	Whisper white powder coated 20 Micron Clear Anodise
Shape	Round Aluminium tube
Flag	Two yard
Mounting	Spigot B, (Aluminium base plate) Rag bolts set in foundations.

Aluminium poles are the superior option since they are more durable than timber, steel or fibreglass equivalents.

Reinforcing sleeve welded to baseplate
Dia. 73mm x 5 wt

1400
Dia. 80mm
x 2 wt

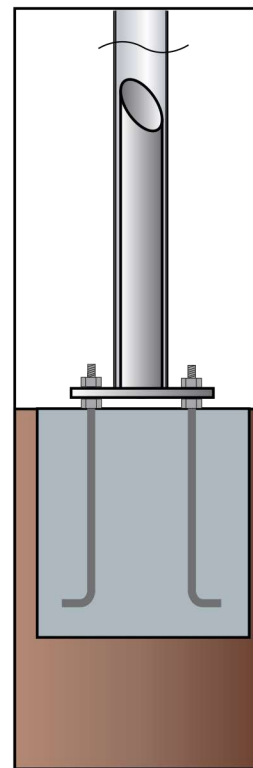

Spigot 'B', welded to baseplate

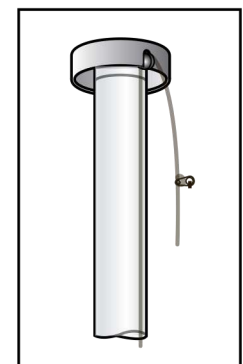

External halyard top detail

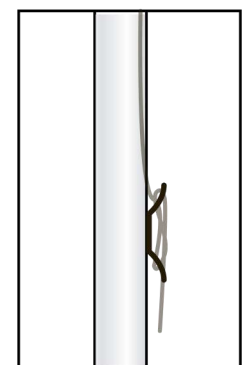

External halyard bottom detail

Cast alloy finial

46mm dia.

6 / 7.5m

Specification Description:

6m/7.5m Al flagpole 80mm OD x 2mm wall, top 2m tapered to 46mm OD, cast Al mushroom finial, white powder coated finish, spigot A [tube only], external halyard and flag clips ready to fly a 2 yard flag.

Goldspar code: FP680SAEH

Pole	External Halyard Flagpole
Height	6 / 7.5 Metre
Material	Aluminium 6063T6
Finishes	Whisper white powder coated 20 Micron Clear Anodise
Shape	Round Aluminium tube
Flag	Two yard
Mounting	Spigot A , (spigot in ground) Dia. 73mm x 5mm Al. tube Note: plastic wrap is recommended to protect aluminium from alkaline soil attack.

Aluminium poles are the superior option since they are more durable than timber, steel or fibreglass equivalents.

1400

80mm dia.

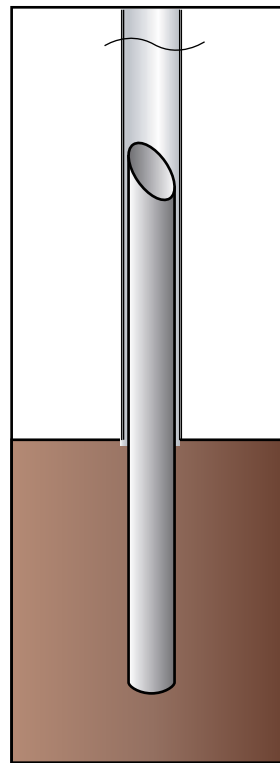

Inground Spigot 'A'

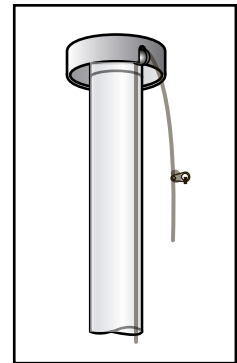

External halyard top detail

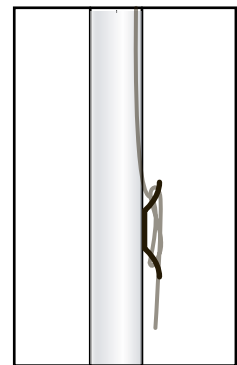

External halyard bottom detail

Cast alloy finial

46mm dia.

6 / 7.5m

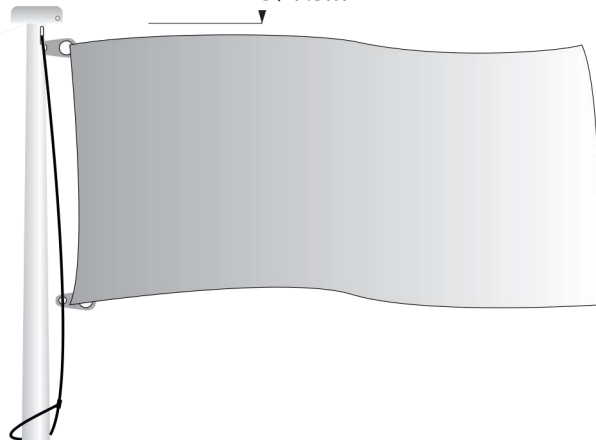

Specification Description:

6m/7.5m Al flagpole 80mm OD x 2mm wall, top 2m tapered to 46mm OD, cast Al mushroom finial, white powder coated finish, spigot B [aluminium base plate 195mm square + 2m structural aluminium tube] with 4 x M16 x 600mm long galvanised steel foundation bolts, internal halyard and flag clips ready to fly a 2 yard flag. #FP680SAIH

Pole Internal Halyard Flagpole

Height 6 / 7.5 Metre

Material Aluminium 6063T6

Finishes Whisper white powder coated
20 Micron Clear Anodise

Shape Round Aluminium tube

Flag Two Yard

Mounting Spigot B, (Aluminium base plate)
Rag bolts set in foundations.

Aluminium poles are the superior option since they are more durable than timber, steel or fibreglass equivalents.

Reinforcing sleeve welded to baseplate
Dia. 73mm x 5 wt

1400
Dia. 80mm
x 2 wt

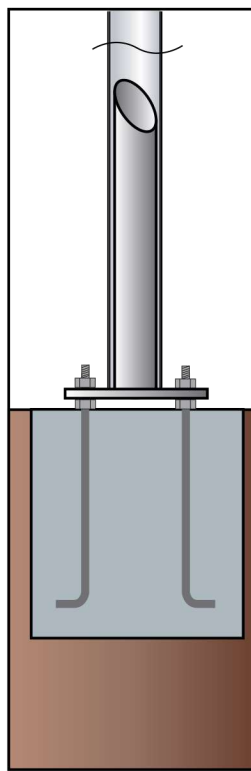
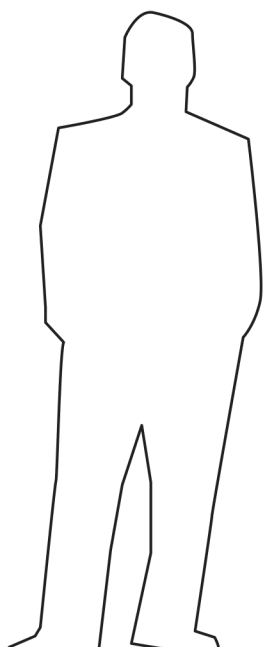

Spigot 'B', welded to baseplate

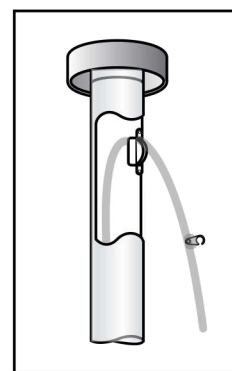

Internal halyard top detail

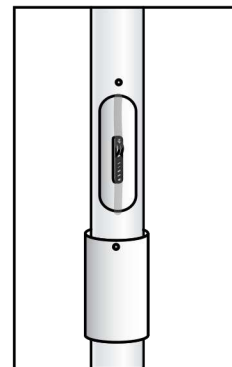

Internal halyard base detail

Cast alloy finial

46mm dia.

6 / 7.5m

Specification Description:

6m/7.5m Al flagpole 80mm OD x 2mm wall, top 2m tapered to 46mm OD, cast Al mushroom finial, white powder coated finish, spigot A [tube only], internal halyard and flag clips ready to fly a 2 yard flag. #FP680SAIH

Pole	Internal Halyard Flagpole
Height	6 / 7.5 Metre
Material	Aluminium 6063T6
Finishes	Whisper white powder coated 20 Micron Clear Anodise
Shape	Round Aluminium tube
Flag	Two Yard
Mounting	Spigot A , (spigot in ground) Dia. 73mm x 5mm Al. tube Note: plastic wrap is recommended to protect aluminium from alkaline soil attack.

Aluminium poles are the superior option since they are more durable than timber, steel or fibreglass equivalents.

1400

80mm dia.

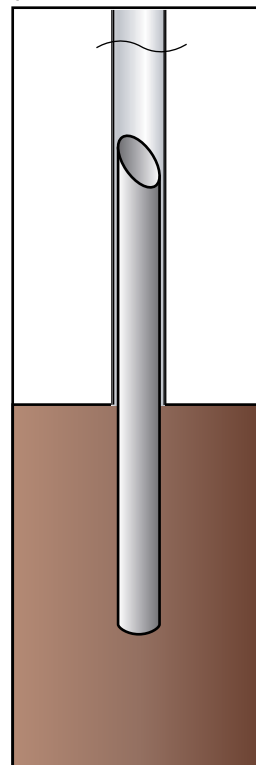

Spigot 'A', embedded in ground

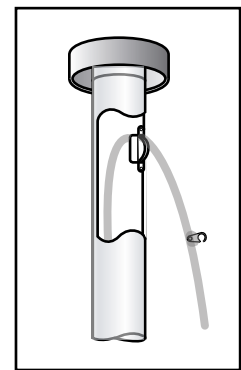

Internal halyard top detail

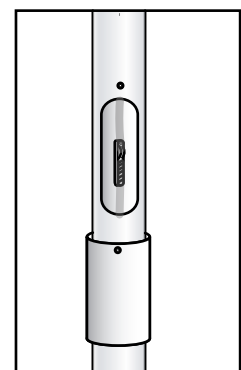

Internal halyard base detail

Cast alloy Finial

46mm dia.

9m

Specification Description:

9m 2-piece aluminium flag pole, bottom section 100mm OD x 2.5mm wall x 6.5m long, top 2.5m long section tapered from 100mm OD to 46mm OD with a neat socket joint into bottom section, cast Al mushroom-shaped finial, white powder coated finish, spigot A [tube only], external halyard and flag clips ready to fly a 3 yard flag.

Goldspar Code: FP9100SAEH

Pole	External Halyard Flagpole
Height	9 Metre
Material	Aluminium 6063T6
Finishes	Whisper white powder coated 20 Micron Clear Anodise
Shape	Round Aluminium tube
Flag	Three Yard
Mounting	Spigot A, (spigot in ground) Dia. 92mm x 5mm Al. tube Note: Plastic wrap is recommended to protect aluminium from alkaline soil attack.

Aluminium poles are the superior option since they are more durable than timber or fibreglass equivalents.

Spigot in ground
Dia. 92mm x
5mm

Dia. 100mm
x 2.5 wt

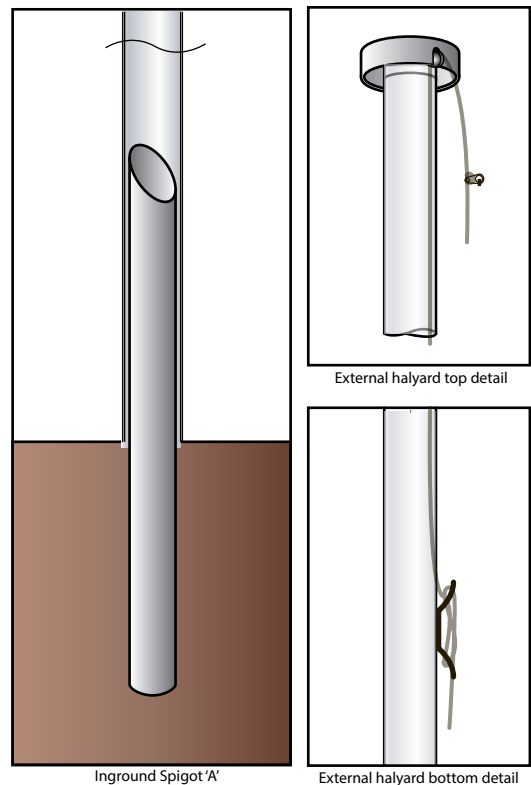

Cast alloy finial

46mm dia.

9m

Specification Description:

9m 2-piece aluminium flagpole, bottom section 100mm OD x 2.5mm wall x 6.5m long, top 2.5m long section tapered from 100mm OD to 46mm OD with a neat socket joint into bottom section, cast Al mushroom-shaped finial, white powder coated finish, spigot B [aluminium base plate 195mm square + 2m structural aluminium tube] with 4 x M20 x 600mm long galvanised steel foundation bolts, external halyard and flag clips ready to fly a 3 yard flag, FP9100SBEH

Pole	External Halyard Flagpole
Height	9 Metre
Material	Aluminium 6063T6
Finishes	Whisper white powder coated 20 Micron Clear Anodise
Shape	Round Aluminium tube
Flag	Three Yard
Mounting	Spigot B, (Aluminium base plate) Rag bolts set in foundations.

Aluminium poles are the superior option since they are more durable than timber, steel or fibreglass equivalents.

Reinforcing sleeve welded to baseplate
Dia. 92mm x 5 wt

Dia. 100mm
x 2.5 wt

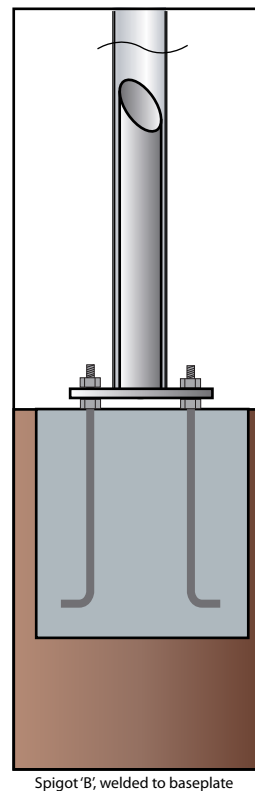

Spigot 'B', welded to baseplate

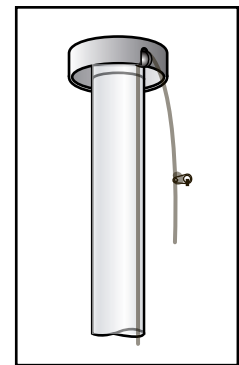

External halyard top detail

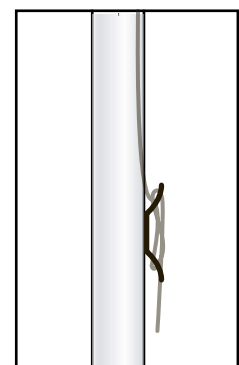

External halyard bottom detail

Cast alloy finial

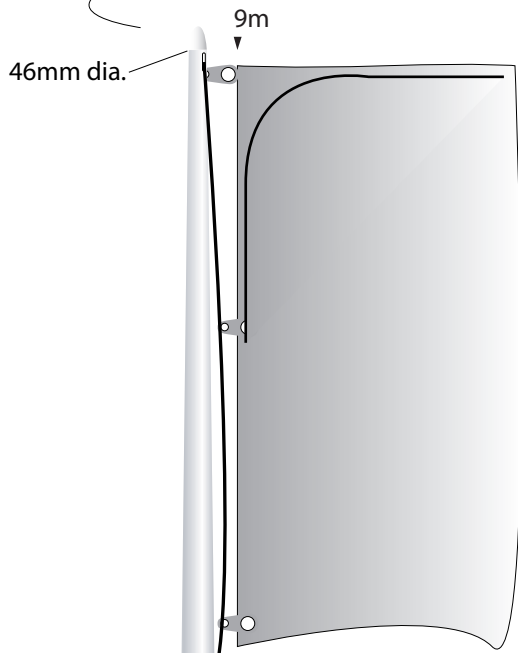

Pole Internal Halyard Banner Pole

Height 9 Metre

Material Aluminium 6063T6

Finishes Whisper white powder coated
20 Micron Clear Anodise

Shape Round Aluminium tube

Flag Three Yard

Mounting Spigot B, (Aluminium base plate)
Rag bolts set in foundations.

Aluminium poles are the superior option since they are more durable than timber, steel or fibreglass equivalents.

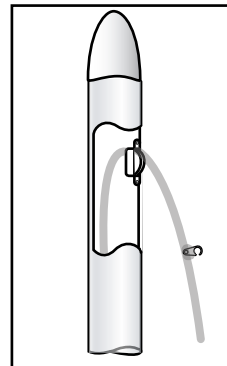

Internal halyard top detail

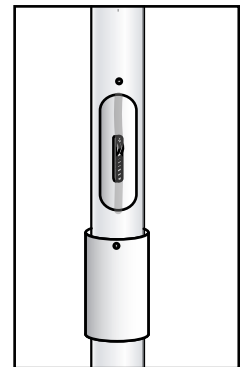

Internal halyard base detail

Reinforcing sleeve welded to baseplate
Dia. 92mm x 5 wt

1400
Dia. 100mm
x 2.5 wt

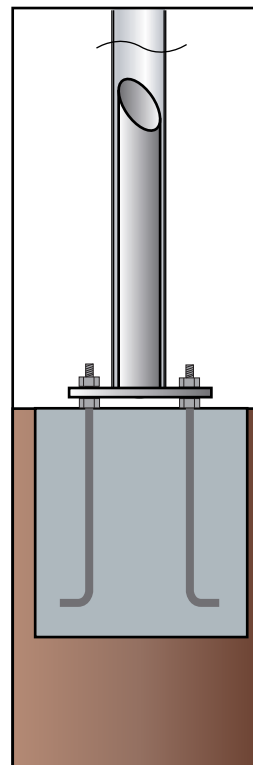
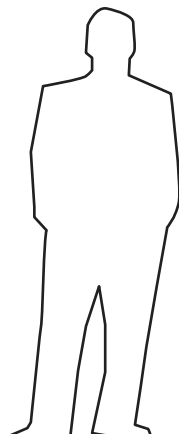

Spigot 'B', welded to baseplate

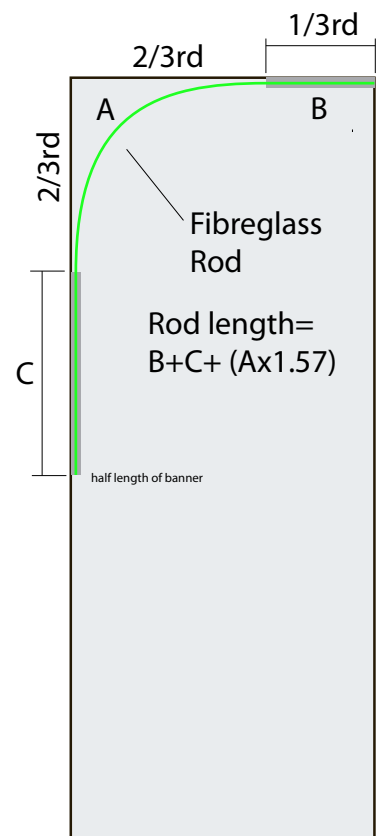

Banner and Fibreglass Rod Batten Arrangement

Cast alloy finial

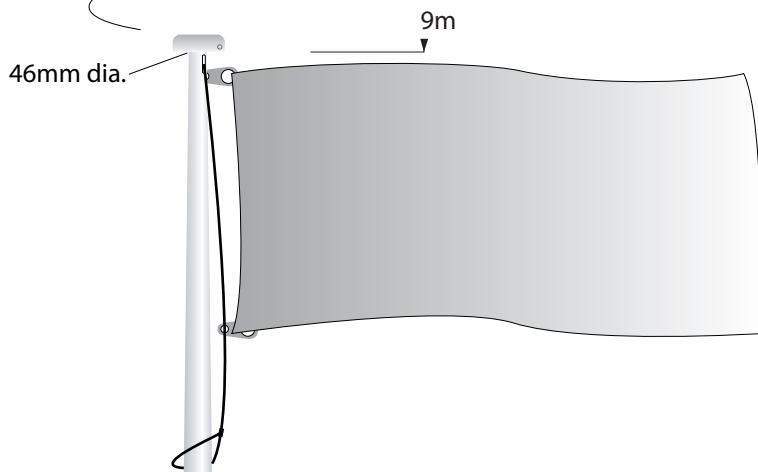

Specification Description:
 9m 2-piece aluminium flagpole, bottom section 100mm OD x 2.5mm wall x 6.5m long, top 2.5m long section tapered from 100mm OD to 46mm OD with a neat socket joint into bottom section, cast Al mushroom-shaped finial, white powder coated finish, spigot A [tube only], internal halyard and flag clips ready to fly a 3 yard flag.

Goldspar Code: FP9100SAIH

Pole	Internal Halyard Flagpole
Height	9 Metre
Material	Aluminium 6063T6
Finishes	Whisper white powder coated 20 Micron Clear Anodise
Shape	Round Aluminium tube
Flag	Three Yard
Mounting	Spigot A , (spigot in ground) Dia. 92mm x 5mm Al. tube Note: Plastic wrap is recommended to protect aluminium from alkaline soil attack.

Aluminium poles are the superior option since they are more durable than timber or fireglass equivalents.

Spigot in ground
 Dia. 92mm x
 5mm

1400
 Dia. 100mm
 x 2.5 wt

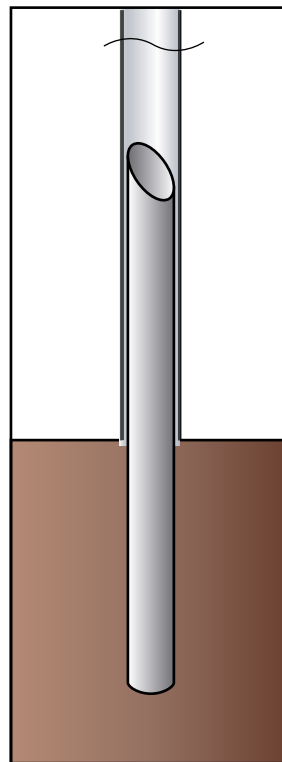
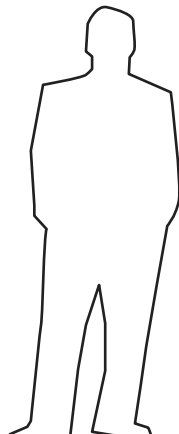

Inground Spigot 'A'

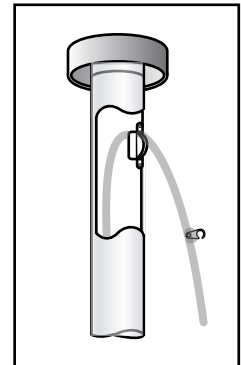

Internal halyard top detail

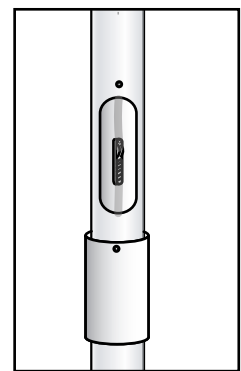

Internal halyard base detail

Cast alloy finial

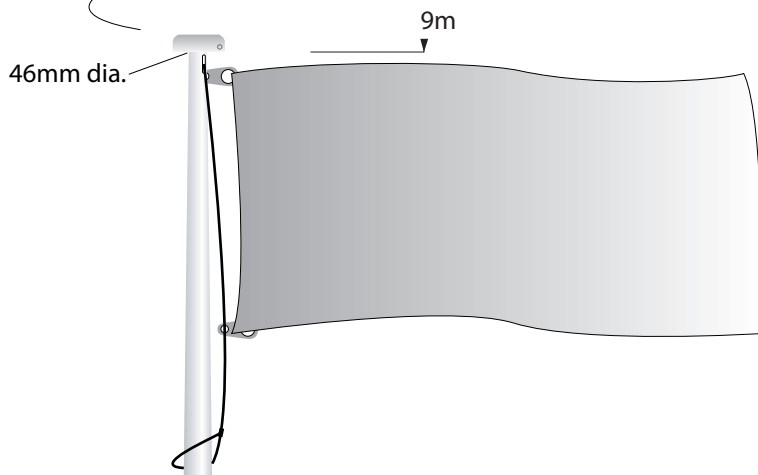

Specification Description:
 9m 2-piece aluminium flagpole, bottom section 100mm OD x 2.5mm wall x 6.5m long, top 2.5m long section tapered from 100mm OD to 46mm OD with a neat socket joint into bottom section, cast Al mushroom-shaped finial, white powder coated finish, spigot B [aluminium base plate 195mm square + 2m structural aluminium tube] with 4 x M20 x 600mm long galvanised steel foundation bolts, internal halyard and flag clips ready to fly a 3 yard flag. FP9100SBIH

Pole	Internal Halyard Flagpole
Height	9 Metre
Material	Aluminium 6063T6
Finishes	Whisper white powder coated 20 Micron Clear Anodise
Shape	Round Aluminium tube
Flag	Three Yard
Mounting	Spigot B , (Aluminium base plate) Rag bolts set in foundations.

Aluminium poles are the superior option since they are more durable than timber, steel or fibreglass equivalents.

Reinforcing sleeve welded to baseplate
 Dia. 92mm x 5 wt

1400
 Dia. 100mm
 x 2.5 wt

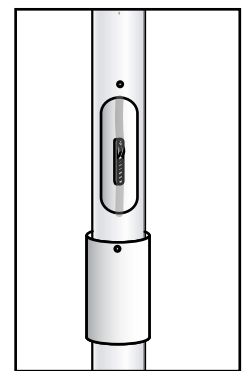
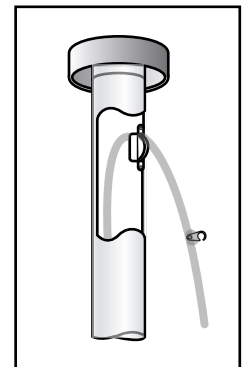
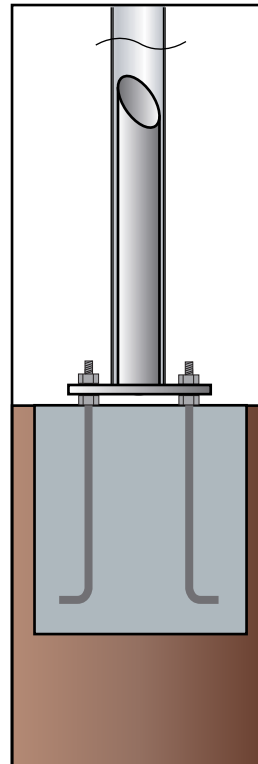
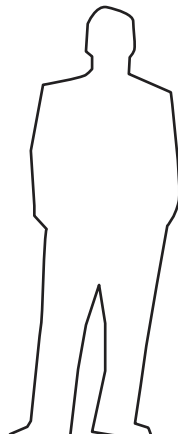

Spun ellipsoid finial

70mm dia.

12m

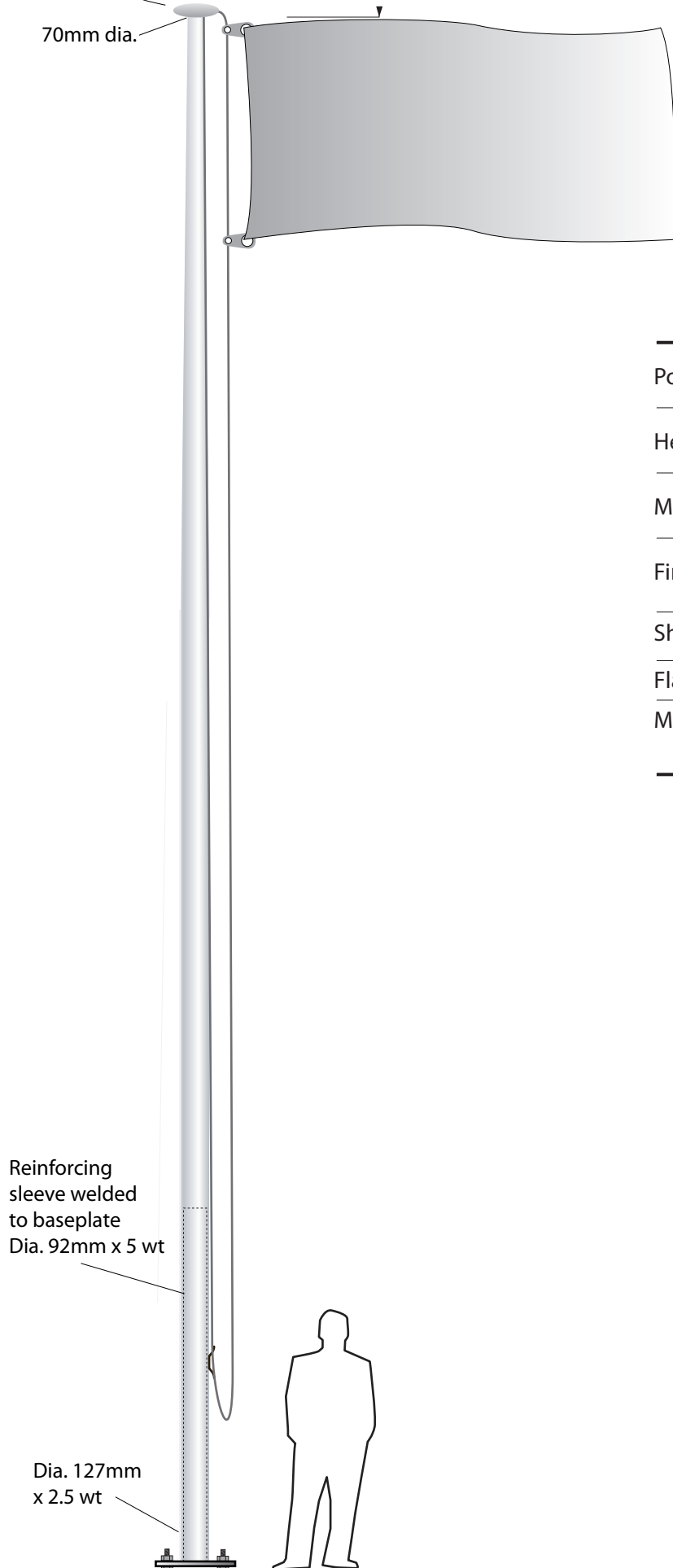

Specification Description:

12m Al flagpole bottom section 127mm OD x 3mm wall x 6.5m long, 5.5m long top section with top 4m tapered from 127mm OD to 80mm OD with a neat socket joint into bottom section, spun ellipsoid finial, white powder coated finish, spigot B [galvanised steel base plate 300mm square x 20mm thick + extended 3m long spigot tube], external halyard and flag clips ready to fly a 3 yard flag, with 4 x M24 x 600mm long galvanised steel foundation bolts. FP12125SBEH

Pole	External Halyard Flagpole
Height	12 Metre
Material	Aluminium 6063T6
Finishes	Whisper white powder coated 20 Micron Clear Anodise
Shape	Round Aluminium tube
Flag	Three Yard
Mounting	Spigot B, (Aluminium base plate) Rag bolts set in foundations.

Aluminium poles are the superior option since they are more durable than timber, steel or fibreglass equivalents.

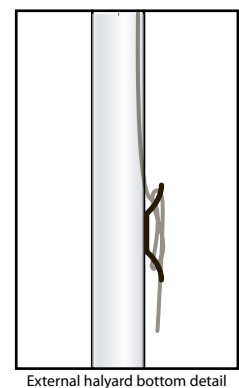
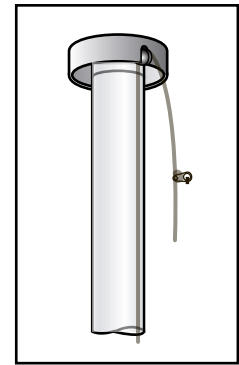
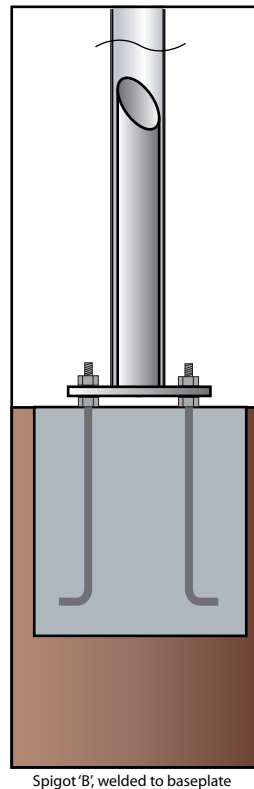

Spun ellipsoid finial

70mm dia.

12m

Reinforcing sleeve welded to baseplate

1400 Dia. 127mm

Specification Description:

12m Al flagpole bottom section 127mm OD x 3mm wall x 6.5m long, 5.5m long top section with top 4m tapered from 127mm OD to 80mm OD with a neat socket joint into bottom section, spun ellipsoid finial, white powder coated finish, spigot B [galvanised steel base plate 300mm square x 20mm thick + extended 3m long spigot tube], internal halyard and flag clips ready to fly a 3 yard flag, with 4 x M24 x 600mm long galvanised steel foundation bolts. FP12125SBEH

Pole	Internal Halyard Flagpole
Height	12 Metre
Material	Aluminium 6063T6
Finishes	Whisper white powder coated 20 Micron Clear Anodise
Shape	Round Aluminium tube
Flag	Three Yard
Mounting	Spigot B, (Aluminium base plate) Rag bolts set in foundations.

Aluminium poles are the superior option since they are more durable than timber, steel or fibreglass equivalents.

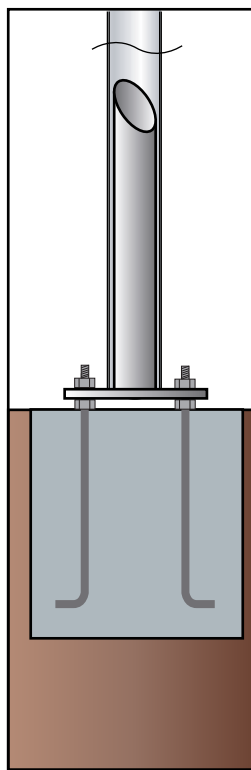

Spigot 'B', welded to baseplate

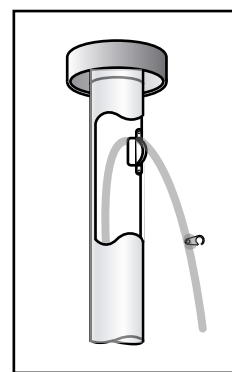

Internal halyard top detail

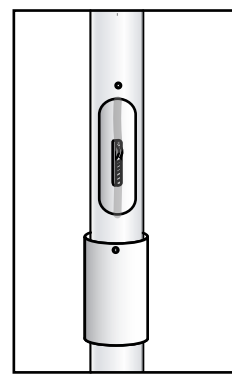

Internal halyard base detail